



AlarmSense[®]
PLUS
REPEATER PANEL

12 ZONE FULLY FUNCTIONAL REPEATER PANEL

**Installation, Commissioning &
Operating Manual**



Haes Technologies Ltd, Unit 3, Horton Industrial Park, West Drayton, UB7 8JD

Model Number

AlarmSense PLUS 12 zone repeater panel ASP-R-12

European Standard EN54-2 : 1997 + A1 : 2006
Control and indicating equipment for fire detection and fire alarm systems for buildings.

European Standard EN54-4 : 1997 + A1 : 2002 + A2 : 2006
Power supply equipment for fire detection and fire alarm systems for buildings.

IMPORTANT NOTE

**PLEASE READ THIS MANUAL BEFORE HANDLING THE EQUIPMENT AND
OBSERVE ALL ADVICE GIVEN IN IT**

THIS PARTICULARLY APPLIES TO THE PRECAUTIONS NECESSARY TO AVOID

E.S.D

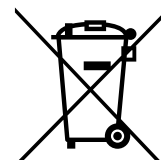

ATTENTION



IMPORTANT SAFETY NOTES

The panel is safe to operate provided it has been installed in compliance with the manufacturer's instructions and used in accordance with this manual.

Hazardous voltages are present inside the panel—DO NOT open it unless you are qualified and authorised to do so. There is no need to open the panel's enclosure except to carry out commissioning, maintenance and remedial work. This work must only be carried out by competent service personnel who are fully conversant with the contents of the panel's installation manual and have the necessary skills for maintaining this equipment.

This fire alarm system requires periodic checks as specified in BS 5839 Part 1 It is the responsibility of the system user to ensure it is regularly serviced and maintained in good working order.

Disclaimer

No responsibility can be accepted by the manufacturer or distributors of this fire alarm panel for any misinterpretation of an instruction or guidance note or for the compliance of the system as a whole. The manufacturer's policy is one of continuous improvement and we reserve the right to make changes to product specifications at our discretion and without prior notice. E & O E.

	Page
ABOUT THIS PANEL	2
PRODUCT OVERVIEW	2
CABINET DETAILS	3
CIRCUIT BOARDS	4
MAIN PCB TERMINALS	5
COMMS PCB TERMINALS	5
TECHNICAL SPECIFICATION	6
POWER SUPPLY MODULE	7
<hr/>	
INSTALLATION	8
SAFETY	8
ESD PRECAUTIONS	9
GENERAL	9
MOUNTING THE CABINET	9
MAINS CONNECTIONS	10
CONNECTING THE BATTERIES	11
CABLING	12
<hr/>	
SETUP & PROGRAMMING	14
INSTALL COMMS PCB	14
SET NUMBER OF REPEATER PANELS	16
REPEATER PANEL ADDRESSING	16
PROGRAMMING REPEATER PANELS	17
<hr/>	
OPERATING	18
PANEL CONTROLS & INDICATIONS	18
DISABLE MODE	20
TEST MODE	21

PRODUCT OVERVIEW

The AlarmSense PLUS repeater panels have the same, easy to use, controls and indications as the main control panel but mounted in a smaller cabinet.

The repeaters are fully functional with 'Silence', 'Resound' and 'Reset' controls, as well as Disable and Test Mode functions. AlarmSense PLUS panels can support up to 8 repeater panels.

Repeater panels are designed to be wired in a fault tolerant (fail safe) loop configuration, from comms A to B and back to the main panel again. This enables repeater panels to still work if there is a break in the cables.

If replacing an older system where the existing cabling cannot be configured in a loop as above, it is possible to re-programme the panel back to legacy RS485 circuit comms monitoring. This then allows any topology of comms cabling to be utilised.

The main circuit board has 2, switch –ve, inputs which can be used to sound or pulse the alarms. These inputs can also be re-programmed for use as PSU fault inputs.

The internal comms PCB has 6, switch –ve, programmable outputs.

Different key types are used for the door lock and the 'activate controls' key-switch. It is also possible to enable the controls via a 4 digit code entry if preferred. An eight button keypad is used to control the system and allow access to the function options (unless disabled).

The control panel comprises of a sheet steel enclosure suitable for wall mounting with a hinged, lockable front access door. It can be semi recessed, using a suitable recessing bezel. Cable entry is via 20mm 'knockouts' located at the top and rear of the cabinet.

The repeaters are supplied with a 1.5 amp internal power supply module. This module complies with the requirements of EN54-4 : 1988 and provides temperature compensated battery management charging.

Quiescent and alarm current details for standby battery calculations

	Standby Current	Alarm Current
ASP-R-12 repeater panel	63mA	85mA

CABINET

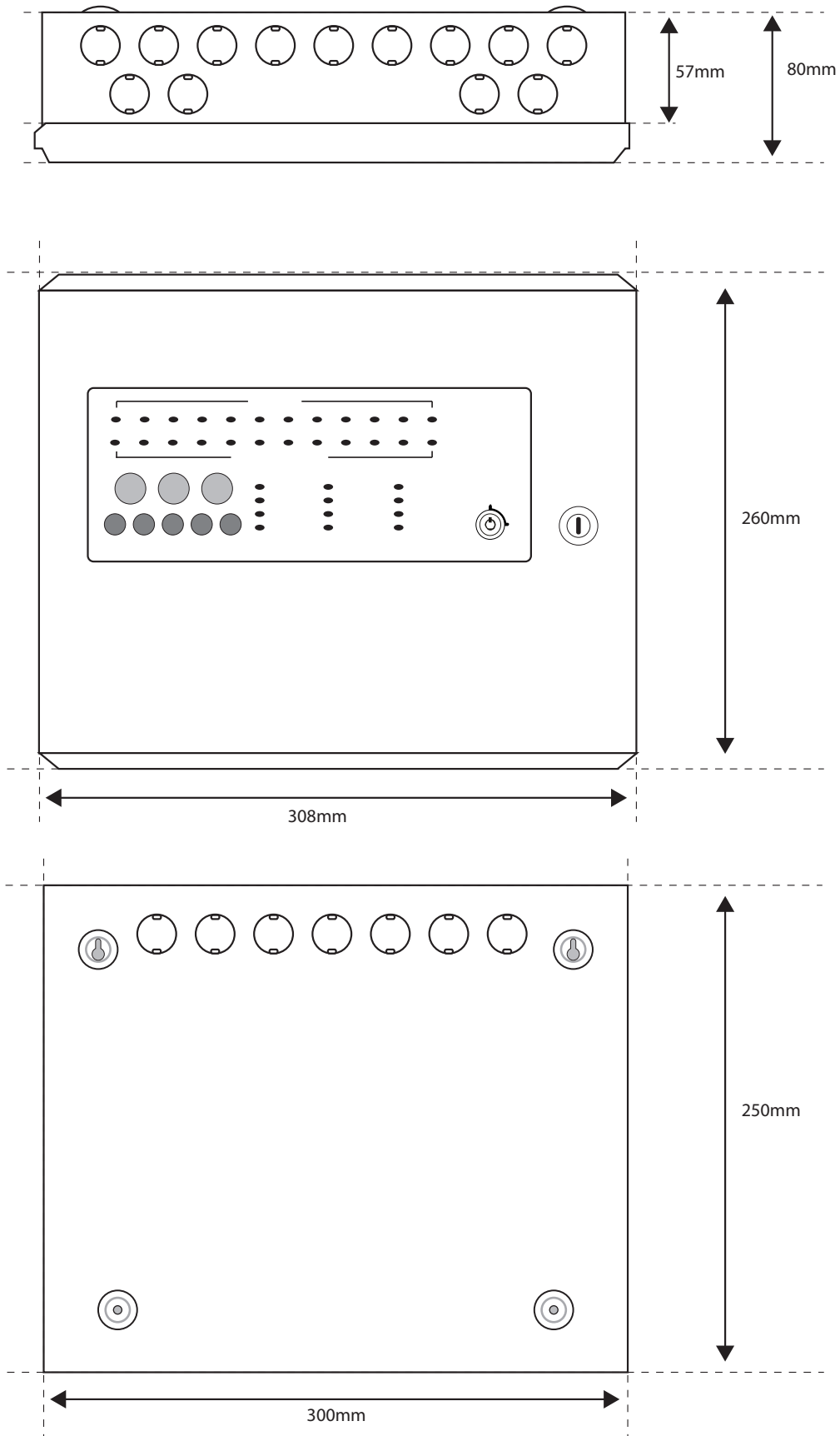

CIRCUIT BOARDS

AlarmSense PLUS repeater panels comprise of three circuit boards

TPCA01-R - Master PCB

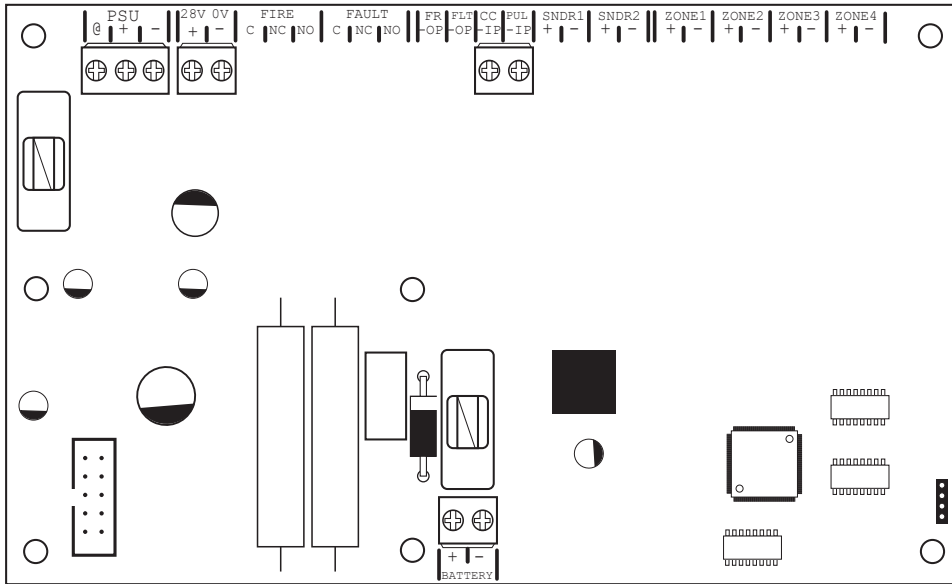

TPCA05 - Comms PCB (with V3.0 software)

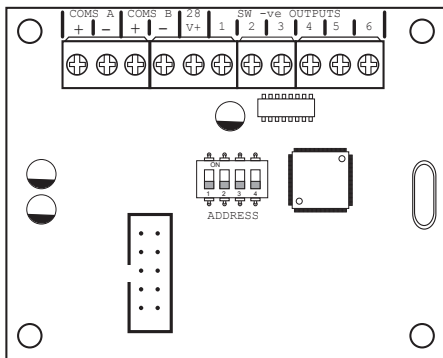

- Piggy backs on Main PCB
- 6 programmable switch -ve outputs

TPCA03 - LED Display & Controls PCB

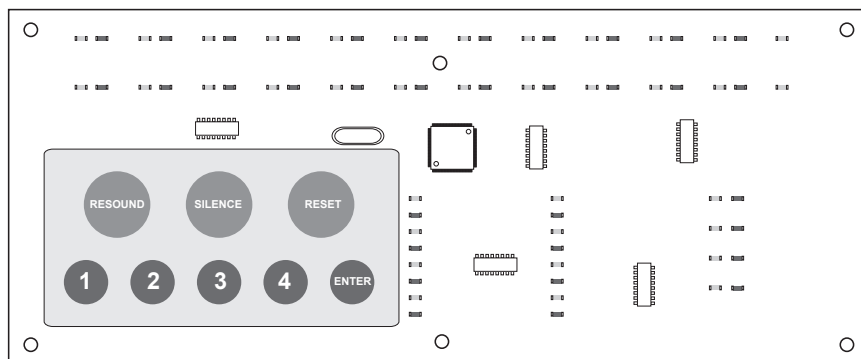

MAIN PCB TERMINALS

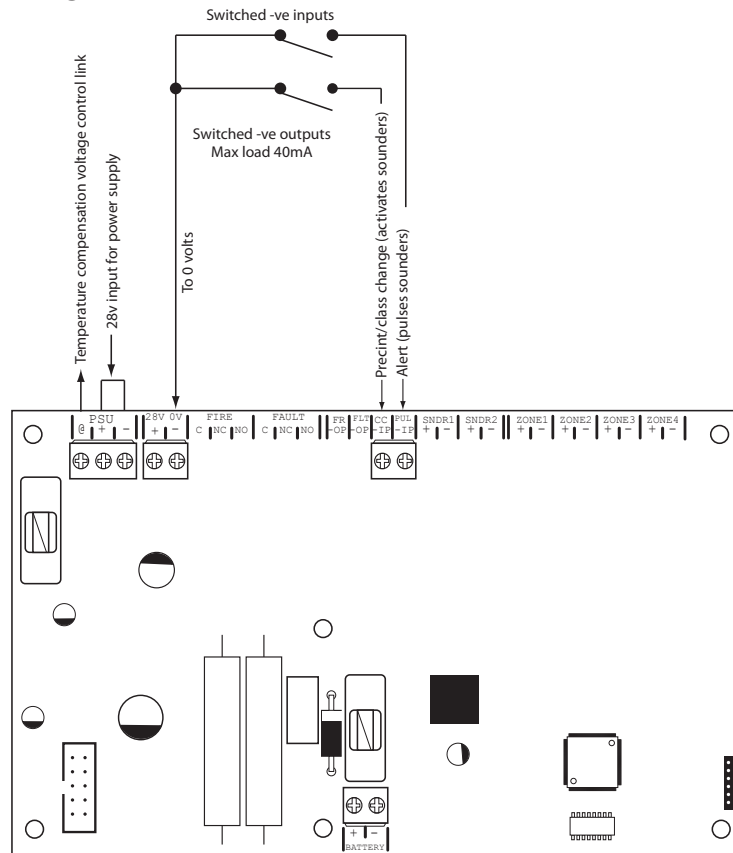

COMMS PCB TERMINALS

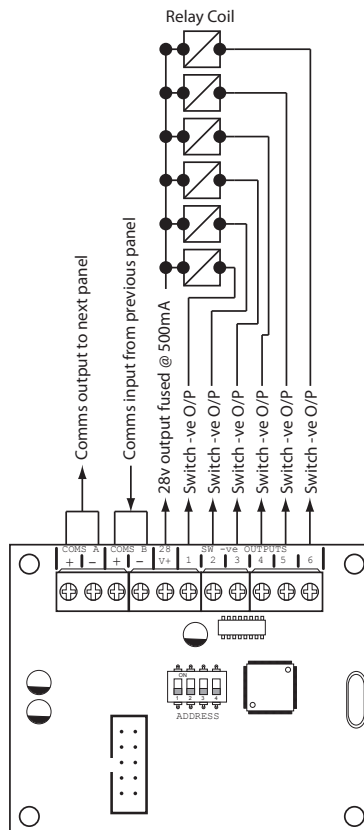

TECHNICAL SPECIFICATION

Electrical Specification Inputs & Outputs - TPCA01-R Main PCB		
Terminal capacity	0.5mm ² to 2.5mm ² solid or stranded wire.	
PSU @ output	Power supply voltage control line.	For temperature compensation control.
PSU Input + -	28vdc supply input. Diode protected for reversal and independent short circuit. Max current 3 amps.	Max input current 3 amps. Input voltage 22vdc to 32vdc.
Inputs; CC, PUL	Switched -ve inputs, connect to 0v to trigger. Max input voltage = 28vdc. Non latching, max resistance 100R.	Protected via 10K Ohm impedance, 3v6 zener diode.

Electrical Specification Inputs & Outputs - TPCA05 comms PCB		
Comms A - B	RS485	Repeater Comms, fused @ 20mA
28v	Supply output	Fused @ 500mA
Programmable outputs 1 - 6	Switched -ve outputs	Overload voltage protected to 52vdc Current limited 680R Max load = 40mA

General Specification	
Enclosure	Steel IP30. Epoxy powder coated Interpon Radon, silver grey
Cabling	The use of fire resistant screened cable, is recommended, FireBurn, FP200 or equivalent. Minimum size 1mm ² . Max cable length 1Km Non fire resistant cable can be used, BELDEN 9271 or BELDEN 9860. Maximum cable length 1.2Km
Temperature range	-5 deg C to +40 deg C max RH 95%

POWER SUPPLY MODULE

Power Supply Specification		
Mains supply	230vac +10% / -15% 50Hz max current 1A	
Mains supply fuse	2 Amp (T2A 250V)	Not accessible for servicing. Internal to switch mode power unit
Internal power supply rating	1.5 Amps total including battery charging	Maximum load shared between outputs = 900mA
Maximum continuous load for battery standby (ImaxA)	ImaxA = 575mA	ImaxB not specified
Minimum current drawn by repeater panel	I min = 63mA	
Maximum ripple	250 millivolts	Supply and charger fault monitored
Min/max battery size and type	2 x 3.2Ahr 12volt VRLA Use Yuasa NP range batteries	Batteries shall comply to BS 62368-1 requirements. Fire rated batteries shall be used.
Battery charging voltage	27.3 vdc nominal at 20 deg C	Temperature compensated
Battery charging output current	1.5A PSU 630mA Current limited 10 Ohms	
Battery high impedance fault (Batt Hi Z)	Resistance > 1 Ohm	1 hour reporting time
Max current drawn from batteries	1.5 Amps with main power source disconnected. Battery fuse 3A LBC 20mm.	

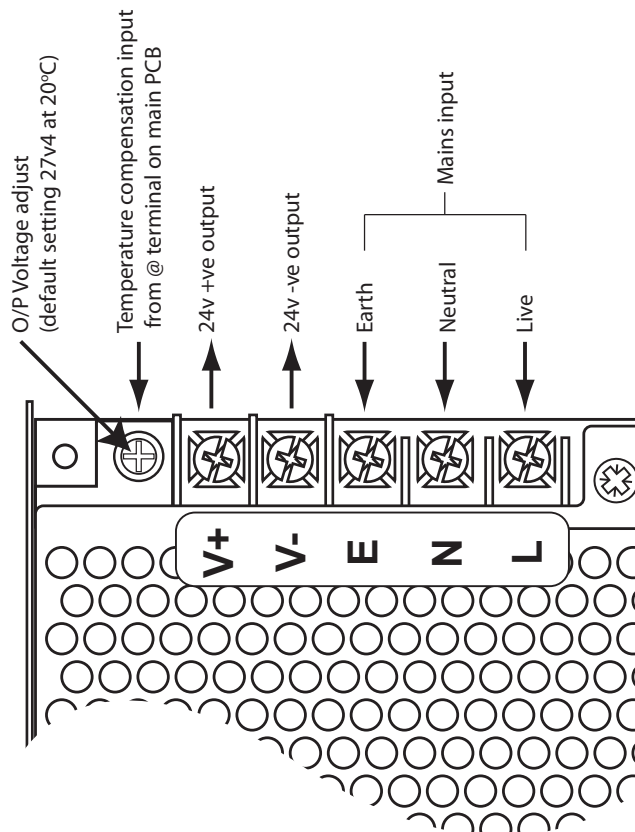

SAFETY

Suppliers of articles for use at work are required under section 6 of the Health and Safety at Work Act 1974 to ensure as reasonably as is practical that the article will be safe and without risk to health when properly used. An article is not regarded as properly used if it is used “without regard to any relevant information or advice” relating to its use made available by the supplier.

It is assumed that the system, of which this control panel is a part, has been designed by a competent fire alarm system designer in accordance with BS 5839 Part 1 and with regard to BS EN 54 parts 2 and 4 in the case of control equipment and power supplies. Design drawings should be provided to clearly show the position of any field devices and ancillary equipment.

This product should be installed, commissioned and maintained by, or under the supervision of, competent persons according to good engineering practice and,

- (i) BS 7671 (IEE wiring regulations for electrical installations)
- (ii) Codes of Practice
- (iii) Statutory requirements
- (iv) Any instructions specifically advised by the manufacturer

According to the provisions of the Act you are therefore requested to take such steps as are necessary to ensure that any appropriate information about this product is made available by you to anyone concerned with its use.

This equipment is designed to be operated from 230V AC 50/60 Hz mains supplies and is of Class I construction. As such it must be connected to a protective earthing conductor in the fixed wiring of the installation. Failure to ensure that all conductive accessible parts of this equipment are adequately bonded to the protective earth will render the equipment unsafe.

	<p>This equipment must only be installed and maintained by a suitably skilled and technically competent person.</p> <p>THIS IS A PIECE OF CLASS 1 EQUIPMENT AND MUST BE EARTHED</p>
---	--

These panels are designed to comply with the requirements of EN 54 part 2.

Installation of the panel should only be carried out by qualified personnel. The electronic components within the panel can be damaged by static charge. Suitable precautions must be taken when handling circuit boards. Never insert or remove boards or components, or connect cables, with the mains power on or batteries connected.

Equipment Guarantee	
<p>This equipment is not guaranteed unless the complete system is installed and commissioned in accordance with the laid down national standards by an approved and competent person or organisation.</p>	
	<p>This product has been manufactured in conformance with the requirements of all applicable EU Council Directives</p>

ESD PRECAUTION

Electronic components are vulnerable to damage by Electrostatic Discharges (ESD). An ESD wrist strap, suitably grounded, should be worn at all times when handling pcbs. These wrist straps are designed to prevent the build up of static charges, not only within a persons body, but on many other materials. ESD damage is not always evident immediately, faults can manifest themselves at anytime in the future. All pcbs should be stored in static shielded bags (silvered) for safe keeping, when not mounted in the control panel.

GENERAL

Care should be taken with regards to avoiding the close proximity of high voltage cables or areas likely to induce electrical interference. Earth links should be maintained on all system cables and grounded in the control panel. The detection and sounder circuit cabling is classed as extra low voltage and must be segregated away from mains voltage.

- Any junction boxes used should be clearly labelled FIRE ALARM.
- Any ancillary devices, e.g. door retaining magnets, must be powered from a separate power source.
- Any coils or solenoids used in the system must be suppressed, to avoid damage to the control equipment.

MOUNTING THE CABINET

The site chosen for the location of the panel should be clean, dry and not subject to shock or vibration. Damp, salt air or environments where water ingress or extremes of temperature may affect the panel must be avoided. The temperature should be in the range -5° to $+40^{\circ}\text{C}$, and the relative humidity should not exceed 95%.

Before mounting the cabinet remove the main PCB.

Remove the power supply module connecting wires from the main PCB, taking care to note where to re-connect them. The main PCB can then be carefully pulled off it's mounting clips.

Secure the cabinet to the wall using the four indented holes in the back box. Ensure the box is mounted level and in a convenient location where it may be easily operated and serviced.

External cables should be glanded via preformed knockouts at the top and rear of the cabinet. Remove any knockouts and ensure the cabinet is clear of swarf etc prior to refitting the PCB. Always ensure that if a knockout is removed, the hole is filled with a good quality cable gland. Any unused knockouts must be securely blanked off.

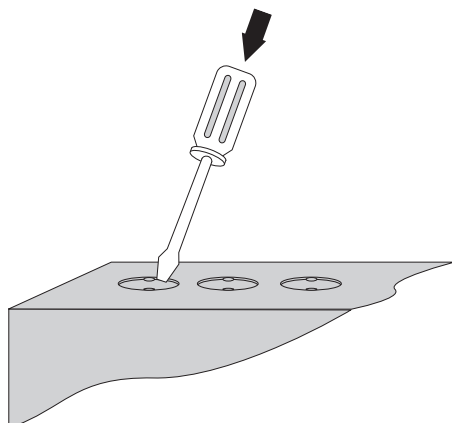

Knockouts should be removed with a sharp tap at the rim of the knockout using a flat 6mm broad bladed screwdriver.

Use of excessive force will damage the enclosure around the knockout.

Typical panel layout

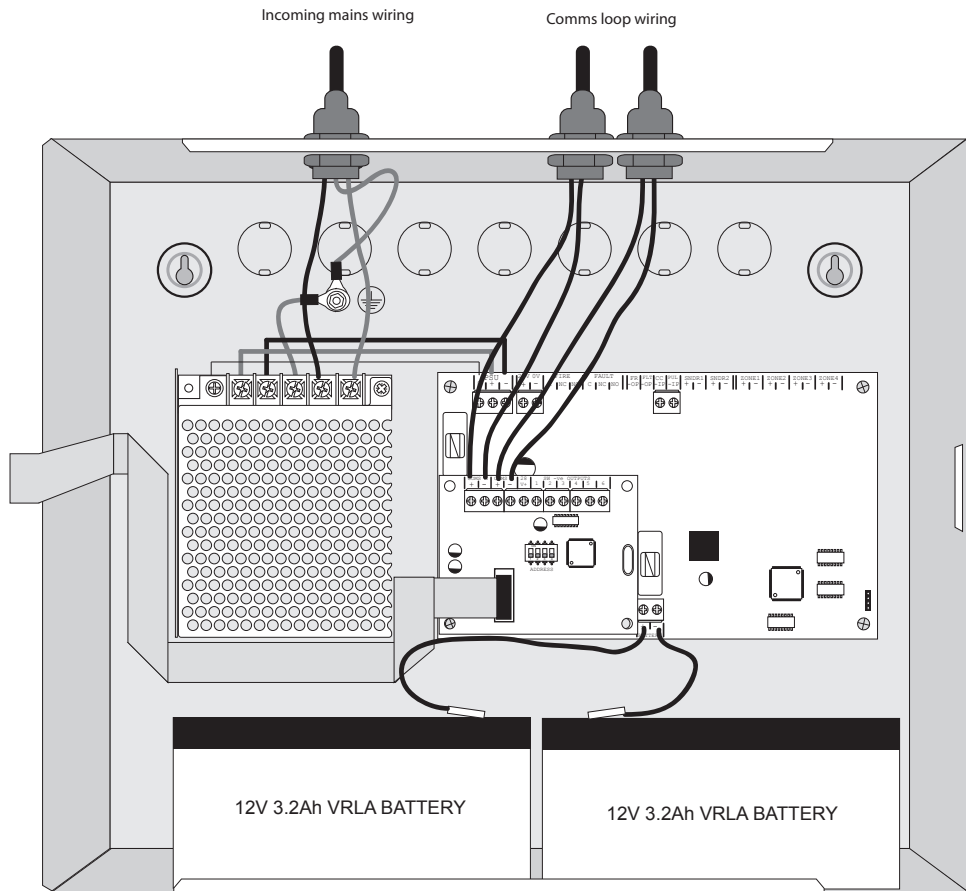

Drawing shows typical internal layout of a repeater panel with two 3.2Ah, 12v batteries fitted

MAINS CONNECTIONS

Do not connect the mains supply to the panel until you are fully conversant with the layout and features of the equipment.

A rating plate is attached to the power supply module describing the nature of the supply permitted.

The incoming mains supply should be brought into the panel via one of the knockouts provided.

A suitable cable gland must be used to secure the outer sheath of the cable used. The earth must first be connected to the primary earth stud (peg) marked with a  symbol, using a suitable ring crimp.

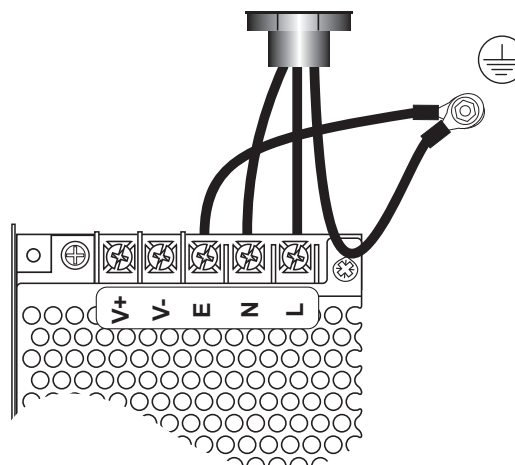

Sufficient earth lead should be left to allow Live and Neutral connections to be accidentally pulled from the terminal block while leaving the earth connection intact.

CONNECTING THE BATTERIES

Batteries of even very small capacity are capable of delivering very high currents which can cause fire or injury, therefore battery connections should be done with caution.

The panel is supplied with battery leads already connected to the battery terminals on the main PCB. These leads are coloured red for +ve and black for -ve.

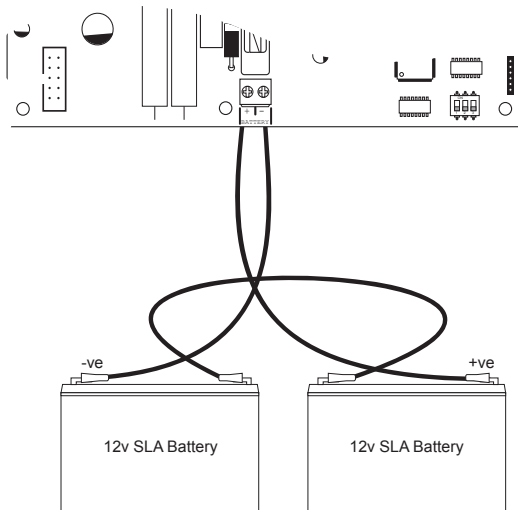

2 x 12v batteries should be connected in series using the white jumper lead provided. See diagram.

To optimise the service life of the batteries, the battery charger output voltage varies with temperature.

N.B.

In the event of mains failure, the battery charger circuit will protect the batteries from full discharge by disconnecting them when they reach below 19v. When the mains supply is restored the batteries will be automatically reconnected.

NOTE:

If the mains is connected before the batteries, the panel will show a Power Supply fault for up to 1 minute until the monitoring cycle has finished polling. This is normal. If the fault doesn't clear after 1 minute, check connections.

BATTERY CHARGING VOLTAGE CHECKS

The battery charging voltage is factory calibrated to 27.3vdc +/- 0.2v @ 20°C. This should not normally require adjustment. Where battery problems are experienced, the following information should be considered.

- a) If a battery is disconnected from the charger, no voltage will appear on the output leads or terminals, due to intelligent battery controls.
- b) Check the power supply voltage at the 28v & 0v supply output terminals. With the batteries disconnected the voltage should be 27.6vdc +/- 0.2v @ between 11°C - 40°C.
- c) To test the batteries, turn off the mains and see if the system will run on the batteries. Check the battery voltage, should be 26.8v for a good battery or 22v for a flat battery.
- d) The power supply voltage can be adjusted using the potentiometer on the power supply module (see page 7), checking at the 28v & 0v output terminals with a calibrated volt meter. Batteries should be disconnected. Carefully adjust the voltage to 27.6vdc +/- 0.2v. When completed, re-connect the batteries.
- e) When the panel is re-charging a low battery, it should be possible to see the voltage across the batteries increase gradually. If this is not occurring, the batteries or the panel may be faulty.

To change the Comms monitoring type at the main control panel use:

2 1 2 3 **Panel Wide Settings**

There are 6 general, panel wide, settings available.

Enter the above code and press the ENTER button. The 6 programmable options are represented by fire zone LEDs 1 - 6, Option 6 being the, 'change repeater comms monitoring type' setting.

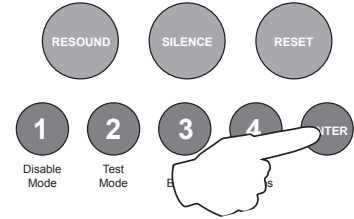

Use button 1 to move to option 6

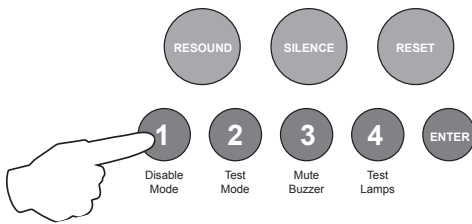

Fire LED	Programming Option
1	Change / remove keypad access code
2	Set number of repeater panels on system
3	Set output delay time (1 - 10 minutes)
4	Turn off battery monitoring
5	Set up internal PCB configuration (add extension zone card or repeater comms PCB)
6	Change repeater comms monitoring

6. Repeater Comms Monitoring Type

With the zone 6 fire LED lit, the amber, fault / disabled / test LEDs will show the current setting.

LED 1 OFF = fault tolerant monitoring (default). LED 1 ON = legacy, radial circuit monitoring.

Press the ENTER button, zone 6 fire LED will pulse to indicate 'edit mode'.

Now use button 2 to change the setting (LED 1 ON or OFF).

When finished press the ENTER button again and the zone 6 fire LED will return to steady 'view mode'.

Press button 1 for 3 seconds to exit programming mode 2-1-2-3.

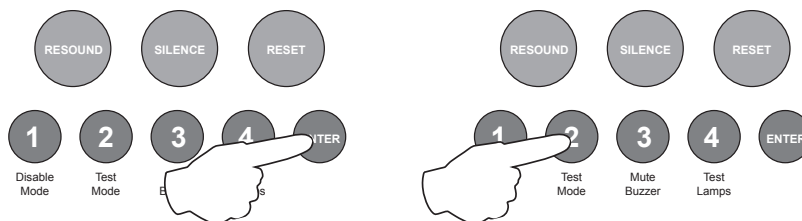

REPEATER PANEL SETUP & PROGRAMMING

The panels can support up to 8 repeaters. The repeater panels are fully functional with 'Silence' 'Resound' and 'Reset' controls, as well as Disable and Test Mode functions. It is possible to disable the controls of each or all repeater panels to make them passive.

Repeater Comms PCB

To run repeaters, a Comms PCB (TPCA05) must be fitted to the main control panel. A Comms PCB for the control panel is supplied, as standard, with each repeater panel. The repeater panels themselves already have the comms board fitted.

The Comms PCB fits into the control panel on top of the main circuit board where the ribbon cable from the display board is normally plugged.

To fit the Comms PCB, power down the panel, un-plug the display board ribbon cable from the main circuit board and plug the Comms PCB into the socket instead.

A socket is provided on the top of the Comms PCB to re-connect the display board ribbon cable.

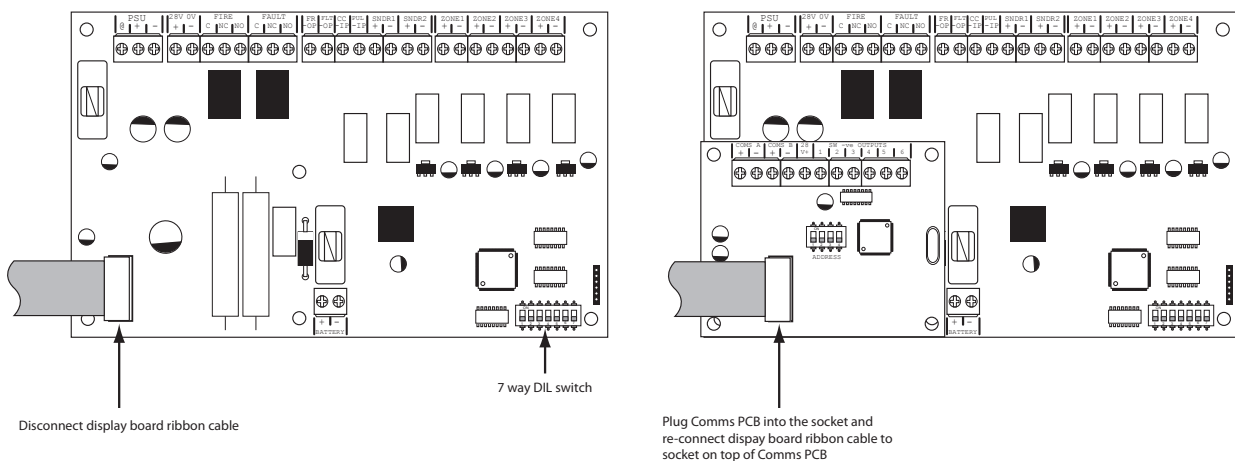

Once the Comms PCB has been fitted, the control panel will need to be programmed for the additional circuit board. To programme the main control panel for the additional PCB see over (page 15).

Next, the panel will need to be programmed for the number of repeater panels on the system. To set up the number of repeater panels on the system, see page 16.

All repeater programming is done at the main control panel with Level 3 programming mode active, see main control panel instruction manual.

To change the internal PCB configuration at the main control panel use:

2 1 2 3 **Panel Wide Settings**

There are 6 general, panel wide, settings available.

Enter the above code and press the ENTER button. The 6 programmable options are represented by fire zone LEDs 1 - 6, Option 5 being the, 'set up internal PCB configuration' setting.

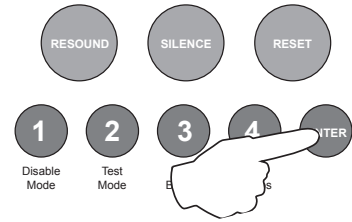

Use button 1 to move to option 5

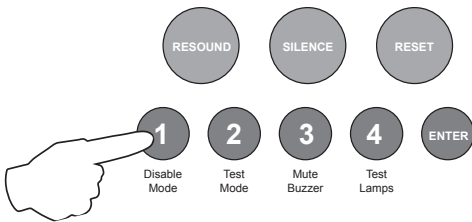

Fire LED	Programming Option
1	Change / remove keypad access code
2	Set number of repeater panels on system
3	Set output delay time (1 - 10 minutes)
4	Turn off battery monitoring
5	Set up internal PCB configuration (add extension zone card or repeater comms PCB)
6	Change repeater comms monitoring

5. Setup Internal PCB Configuration

With the zone 5 fire LED lit, the amber, fault LEDs will show the current configuration setting. Each of the 3 possible additional internal PCBs are represented by LEDs 1 - 3 as per table below.

LED 1 (ON)	LED 2 (ON)	LED 3 (ON)
Extension zone card 1 (zones 5 - 8)	Extension zone card 2 (zones 9 - 12)	Repeater Comms PCB

Press the ENTER button, zone 1 fire LED will pulse to indicate editing of 1st additional PCB as per table above. Use button 1 to move to pulsing fire LED 3.

Now use button 2 to change the setting (Amber LED ON = PCB included, OFF = not included).

When finished press the ENTER button again and the zone 5 fire LED will return to steady 'view mode', with the amber, fault LEDs showing the new configuration.

Press button 1 for 3 seconds to exit programming mode 2-1-2-3.

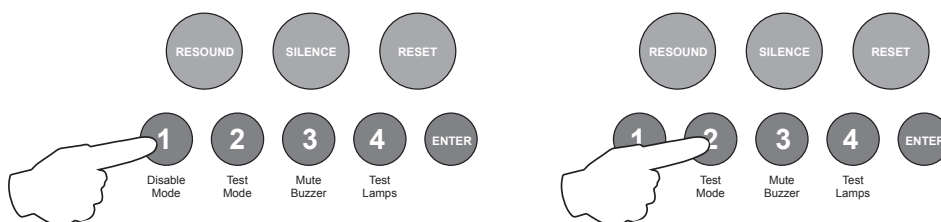

To set the number of repeater panels at the main control panel use:

2 1 2 3 Panel Wide Settings

There are 6 general, panel wide, settings available.

Enter the above code and press the ENTER button. The 6 programmable options are represented by fire zone LEDs 1 - 6, Option 2 being the, 'set number of repeater panels' setting.

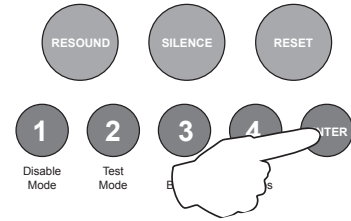

Use button 1 to move to option 2

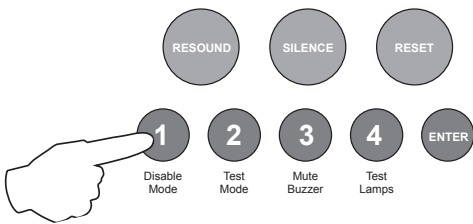

Fire LED	Programming Option
1	Change / remove keypad access code
2	Set number of repeater panels on system
3	Set output delay time (1 - 10 minutes)
4	Turn off battery monitoring
5	Set up internal PCB configuration (add extension zone card or repeater comms PCB)
6	Change repeater comms monitoring

2. Set Number of Repeater Panels on System

With the zone 2 fire LED lit, the amber, fault / disabled / test LEDs will show the current quantity of repeaters set 0 - 8. (1 LED lit = 1 repeater, 2 = 2 etc..).

Press the ENTER button, zone 2 fire LED will pulse to indicate 'edit mode'.

Now use buttons 1 & 3 to increase or decrease the quantity. Button 1 increases, button 3 decreases.

When finished press the ENTER button again and the zone 2 fire LED will return to steady 'view mode'.

Press button 1 for 3 seconds to exit programming mode 2-1-2-3.

Addressing

Each repeater panel needs to have a separate address. The addressing is done using the 4 DIL switches on each of the Comms PCBs using binary code values, see diagram below.

The address should be set in sequence from 1 - 8, first repeater address 01, next repeater address 02 etc. The control panel should always be address 0 (all switches off).

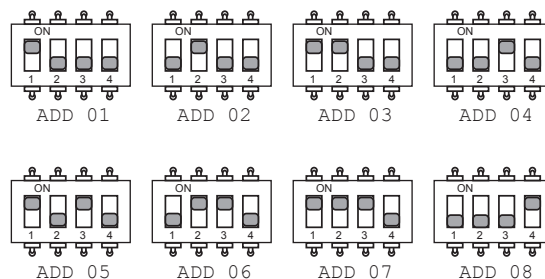

4 4 4 3 **Programming Repeater Panels**

All repeater programming is done at the main control panel with Level 3 programming mode active, see main control panel instruction manual.

The repeater panels have 2 inputs located on the main circuit board, Class Change (CC) and Alert (PUL). Switching a negative voltage into these inputs will cause the alarm sounders to operate. The Class Change input (CC) will cause the alarms to sound continuously and the Alert input (PUL) will cause the alarms to pulse.

There are also 6 switch -ve outputs located on the Comms PCB. By default o/p 1 is set to activate on common fire and o/p 2 is set to activate for common fault.

There are 4 programming options available for the inputs and outputs in the repeater panels.

- Outputs 1 - 6 activate on common fire
- Outputs 1 - 6 activate zonally for zones 1 - 6
- Outputs 1 - 6 activate zonally for zones 7 - 12
- Change inputs CC & PUL to power supply fault inputs.

Enter the above code and press ENTER. The zone 1 fire LED will light. This indicates which repeater panel is to be programmed 1 - 8. Use button 1 to move the fire zone LED to the required repeater.

With the required repeater for editing LED lit, press the ENTER button to enter 'editing mode'. The fire zone 1 LED will now pulse to indicate setting of attribute 1 (outputs 1 - 6 common fire) for that repeater.

Use button 1 to scroll to the attribute that requires editing, indicated by a pulsing fire LED 1 - 4 as per table below. Now use button 2 to change the setting indicated by the amber, fault LEDs, ON or OFF. Then use button 1 again to move to the next attribute if required.

Fire LED (pulsing)	LED 1	LED 2	LED 3	LED 4
Attribute	O/P 1 - 6 Common Fire	O/P 1 - 6 Zonal (Zones 1 - 6)	O/P 1 - 6 Zonal (Zones 7 - 12)	Inputs For PSU Fault
Default Setting	OFF	OFF	OFF	OFF

Press button 1 for 3 seconds to exit programming mode 4-4-4-3.

Disable the controls and return DIL switch 6 to 'OFF' to exit Level 3 programming mode.

PANEL CONTROLS & INDICATIONS

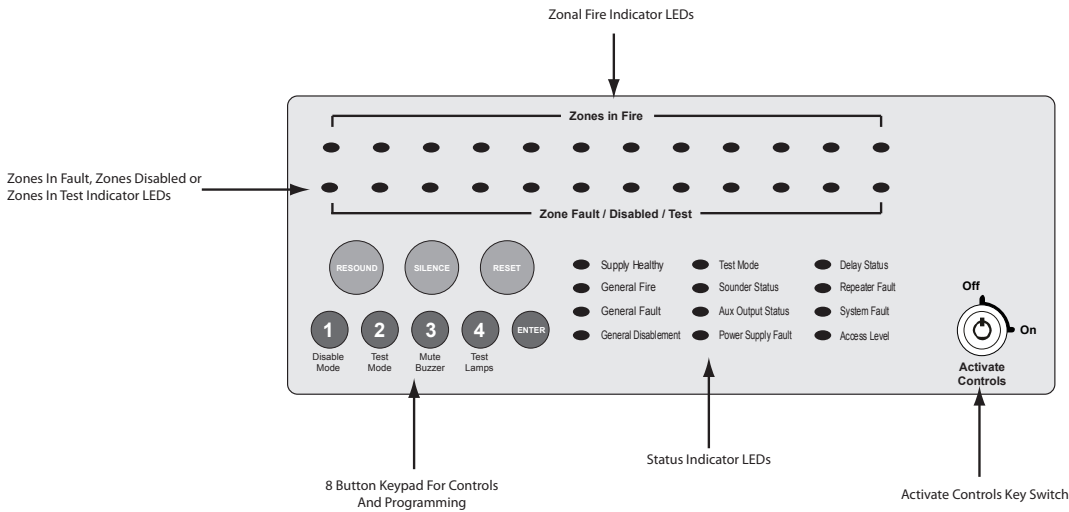

Activate Controls

In normal standby mode the keypad controls are inactive to protect from unauthorised operation. Controls can be activated by using the 'Activate Controls' key switch or by entering a four digit code using the keypad.

The use of a code entry to activate the controls is enabled by default but can be disabled in the Level 3 engineering functions.

To activate the controls using the key switch; turn the key clockwise to the 'On' position. The 'Access Level' indicator LED will light and all buttons on the keypad will now be operational. To deactivate the controls, turn the key back to the 'Off' position and the 'Access Level' indicator LED will extinguish.

If the key switch is in the 'On' position the keypad will remain active.

NOTE : It is not possible to remove the key in the 'On' position.

To activate the controls using the keypad; first push button 1 or button 2 to initialise the code entry mode. The 'Access Level' indicator will pulse rapidly. After 30 seconds, if the code has not been entered, the panel will return to standby mode.

With the 'Access Level' indicator pulsing, enter the four digit code using buttons 1 - 4. The factory default code is 1-2-3-4 but can be changed in the engineering functions. After entering the four digit code press the 'ENTER' button. The 'Access Level' indicator LED will change to steady and all buttons on the keypad will now be operational.

If the wrong code has been entered the 'Access Level' indicator will continue to pulse. Enter the code again and press the 'ENTER' button. If after 30 seconds the correct code has still not been entered the panel will return to standby and button 1 or 2 will need to be pushed again to initialise code entry mode.

After activation by code entry, controls will automatically deactivate again after 2 minutes and the panel will return to standby mode.

The test lamps and mute buzzer functions are operational without the need to activate controls.

Status LED Indicators

	LED On	LED Pulsing
Zones in Fire 1 - 12	N/A	Indicates alarm condition in zone.
Zone Fault/Disabled/Test 1 - 12	Indicates zone circuit is disabled or in test mode.	Indicates a fault in the zone circuit.
Supply Healthy:	Indicates mains and/or battery supply is present.	N/A
General Fire:	N/A	Indicates panel is in alarm condition.
General Fault:	N/A	Indicates one or more faults are present.
General Disablement:	Indicates one or more circuits have been disabled.	Indicates disablement selection mode is active.
Test Mode:	Indicates one or more circuits are in test mode	Indicates test mode selection is active.
Sounder Status:	Indicates sounder circuits have been disabled or are in test mode	Indicates a fault on one or more sounder circuits.
Aux Output Status:	Indicates auxiliary outputs have been disabled.	N/A
Power Supply Fault:	N/A	Indicates a power supply or battery fault.
System Fault:	Indicates a system failure, panel not functional.	Indicates the panel has recovered from a system fault.
Access Level:	Indicates controls are active (access level 2).	Indicates panel is in configuration mode (access level 3).
Repeater Fault:	N/A	Indicates a fault on one or more repeater panels
Delay Status:	Delays are configured	Delay is running

Keypad

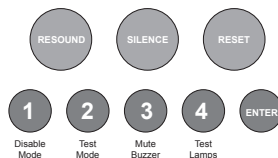

RESOUND (red):	Use to resound the alarms after they have been silenced. Can also be used to invoke full evacuation.
SILENCE (blue):	Use to silence the sounders during an alarm condition.
RESET (green):	Resets the panel back to standby mode.
1: (Disable Mode)	With controls inactive, use to initialise code entry mode for activation of controls. With controls active, use to disable zones, sounder circuits or aux outputs (see DISABLE MODE section). Also has the numeric value 1 for code entry.
2: (Test Mode)	With controls inactive, use to initialise code entry mode for activation of controls. With controls active, use to put zones or sounders circuits into test mode (see TEST MODE section). Also has the numeric value 2 for code entry.
3: (Mute Buzzer)	Mutes the panels internal fire and fault buzzer. (The buzzer will still blip every 5-6 seconds during a fire or fault condition). This function is operational without the need to activate controls. Also has the numeric value 3 for code entry.
4: (Test Lamps)	Use this button to illuminate all LEDs to check that they are working correctly. This function is operational without the need to activate controls. Also has the numeric value 4 for code entry.
ENTER:	This button is used to confirm code entries. It can also be used for fault diagnosis (see FAULT DIAGNOSIS section).

DISABLE MODE

Disable Mode is used to disable or isolate individual zone circuits or all sounder circuits, all auxiliary outputs and any delays to outputs.

To initialise Disable Mode firstly activate the controls by turning the key switch or by entering the four digit code. Then press and hold the Disable Mode button (1) for 3 seconds.

After 3 seconds the panel will bleep and the General Disablement LED and Zone 1 Fault/Disabled/Test LED will pulse slowly, indicating that Zone 1 is in disable selection mode.

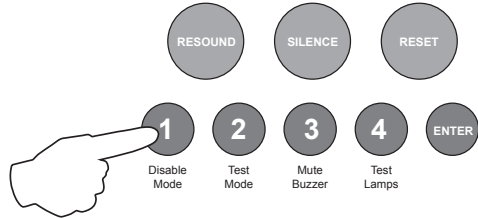

Pressing the Disable Mode button again will move disable selection mode to Zone 2 and the Zone 2 Fault/Disabled/Test LED will be pulsing instead. Subsequent presses will move the selection to Zones 3 - 12, dependant on the number of zones fitted to the panel. I.e up to zone 4 on a 4 zone, 6 on a 6 zone, 8 on a 8 zone etc.

After the last available zone the next press will move the selection mode to the sounder circuits, indicated by the Sounder Status LED and then to the Aux outputs, indicated by the Aux Output Status LED and finally to the Delay LED. Pressing the button once more will move the selection back to Zone 1 again.

When the desired circuit, outputs or delays to be disabled is indicated by a slow pulsing LED, use the ENTER button to select it. Once selected the indicator LED will change to a rapid pulse. Pressing ENTER again will toggle the circuit between disabled and enabled. Then use Disable Mode button again to move to the next circuit. Any or all circuits, outputs or delays can be disabled simultaneously.

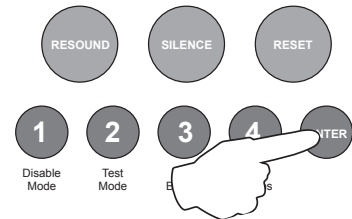

When all disablements have been set, press and hold the Disable Mode button for 3 seconds again. This will exit the disable selection mode and the panel will return to standby. All disabled circuits and the General Disablement will now be indicated by a steady LED.

To enable the circuits again, repeat the above process using the Disable Mode button to select the circuit and the ENTER button to remove the disablement.

Tip:

With the controls active, pressing the Disable Mode button briefly will reveal which circuits are disabled (as opposed to in test mode). This is useful if using Disable Mode and Test Mode at the same time.

TEST MODE

Test Mode is used when testing the fire alarm system. In test mode the devices in the zone(s) in test, detectors and call points etc, can be activated and the panel will automatically reset, enabling the system to be tested by one person. It is possible to test head removal monitoring and to test the system with or without the sounders.

To initialise Test Mode, firstly activate the controls by turning the key switch or by entering the four digit code. Then press and hold the Test Mode button (2) for 3 seconds.

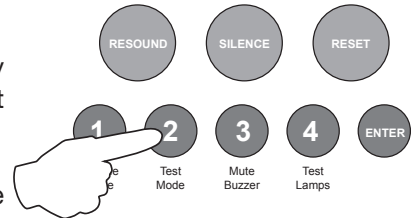

After 3 seconds the panel will bleep and the Test Mode LED and Zone 1 Fault/Disabled/Test LED will pulse slowly, indicating that Zone 1 is in test selection mode. The Sounder Status LED will also be pulsing rapidly, this indicates that the test will be **with** sounders. (Test mode without sounders is explained below)

Pressing the Test Mode button again will move test selection mode to Zone 2 and the Zone 2 Fault/Disabled/Test LED will be pulsing instead. Subsequent presses will move the selection to Zones 3 - 12, dependant on the number of zones fitted to the panel. I.e up to zone 4 on a 4 zone, 6 on a 6 zone, 8 on a 8 zone etc..

After the last available zone the next press will move the selection mode to the sounder circuits, indicated by no Zone Fault/Disabled/Test LEDs on. This position selects whether or not the sounders will ring during test. Pressing the button once more will move the selection back to Zone 1 again.

When the desired zone to be tested is indicated by a slow pulsing LED, use the ENTER button to select it. Once selected the indicator LED will change to a rapid pulse. Pressing ENTER again will toggle the zone between in and out of test. Then use Test Mode button again to move to the next zone. Any or all zones can be in test mode simultaneously.

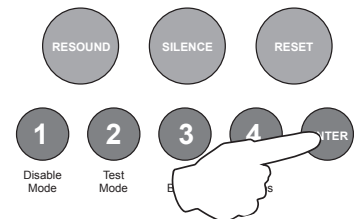

When at the sounder status position, use the ENTER button to toggle between testing with or without sounders. A rapid pulse = with sounders (default), a slow pulse = without sounders.

When all zones to be tested have been selected, press and hold the Test Mode button for 3 seconds again. This will exit the test selection mode. All zones in test and the Test Mode will now be indicated by a steady LED.

To take zones out of test mode, repeat the above process using the Test Mode button to select the zone and the ENTER button to change the status.

Test Mode With Sounders

Activation of a call point or detector - sounders will pulse twice, device is automatically reset.
Removal of a detector - sounders will pulse once.

Test Mode Without Sounders

Activation of a call point or detector - panel buzzer and LED response only, device is automatically reset.

Tip:

With the controls active, pressing the Test Mode button briefly will reveal which circuits are in test mode (as opposed to disabled). This is useful if using Disable Mode and Test Mode at the same time.

www.haes-tech.com